

SMOKER
CRAFT

2020

Five generations in pursuit of our passion.



Tradition begins with the family.

We're not just boat builders. We're boaters, just like you. For five generations and counting, our family has been dedicated to sharing the wonder of boating by creating the finest watercraft that money can buy. That's really all there is to it.

Smoker Craft can trace its roots in the boating industry all the way back to 1921, when the Smoker Lumber Company, as it was then called, was a world leader in the production of oars and paddles. We also built many of the wooden components used in boats produced by several different brands. So in 1963, we built on those four decades of experience and began making boats of our own.

ventilates storage compartments so that gear put away wet doesn't stay that way. Our history is one of constant innovation, and that only results from spending time on the water.

While our designs have evolved over the years, what has remained constant is the painstaking care and meticulous attention to detail that goes into crafting every single one of our boats. Many of our more than 700 employees have been with us for 30 years or more, and their skill and craftsmanship is unmatched in the industry.

We love boating, and we want to share it with the world. That is our commitment. That is our heritage.



Cinda McKinney,
Susan Graff,
Sara Barrett and
Peter Barrett

Although most boats at that time were made entirely from wood, we chose aluminum for its light weight, great strength and maintenance-free durability. Then we added our own innovations, like our Performance Hull System and our acclaimed Hydra-Lift reverse chine hull, our pinch-free seating that protects stray fingers and fishing rod tips from harm, retractable cleats to avoid snagging fishing lines or stubbing toes, and our revolutionary Yarblow system that



President
Doug Smoker
with grandson
Henry Smoker



STANDING STRONG ON FOUR FOUNDATIONS.

Fishing isn't just something you do. It's part of who you are. So when it comes to choosing a fishing boat, second best won't do. That's why, for more than 50 years, Smoker Craft has pushed boundaries with our spacious interior layouts and industry-leading hull designs that deliver superior performance and fuel economy. That's why we continue to drive innovation with features like our Yarblow ventilation system that protects expensive tackle from rust and corrosion, our advanced FreshCatch and FreshCatch Pro livewell systems to keep the catch fresh all the way to the table or the tournament weigh-in, and our Integrated Gunnel Track System that lets you mount accessories anywhere without having to drill any holes. We get this stuff because we're anglers too. That's why we're constantly taking things to the next level with design, engineering and construction that deliver best-in-class aluminum fishing boats for every budget.

THE INDUSTRY'S BEST WARRANTY. PERIOD.

Only a company with the proven history and longevity of a brand like Smoker Craft can offer something like this:

- Limited lifetime warranty on hull and structure
- 6-year warranty on all components, carpet, upholstery and electronics
- All parts and labor
- Transferable to second owner



LIVEWELLS

What's the point in having a livewell if you have to constantly fuss with it? Our FreshCatch Pro recirculating livewells use heavy-duty pumps and PowerStream aerators to move more oxygenated water through the tank and keep fish healthy. Just hit the timer and forget it, so you can focus on the fish below the boat—not the fish that are already in it.

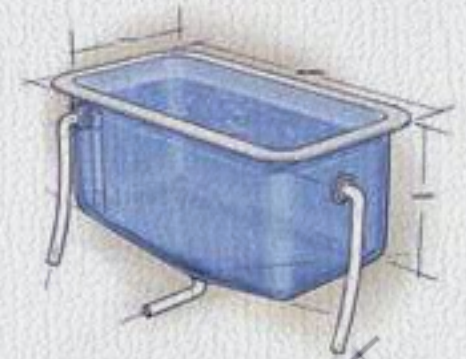

BOW PLATFORMS

Our raised bow casting platforms are carefully designed to give you plenty of elevation for better visibility and more storage space, while maintaining plenty of interior depth for added safety and a dry ride in rough conditions. Our exclusive raked bow design gives you more interior space up front, allowing larger in-deck gear lockers for storing bulky items.

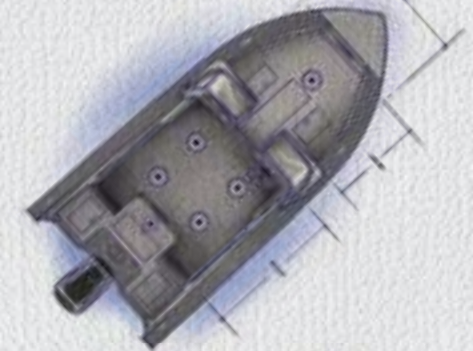

ROD STORAGE

Our rod storage spaces are designed to protect expensive tackle from damage while keeping it readily available for instant access. Select models feature lockable bow in-floor center storage that holds up to eight rods securely in individual tubes.

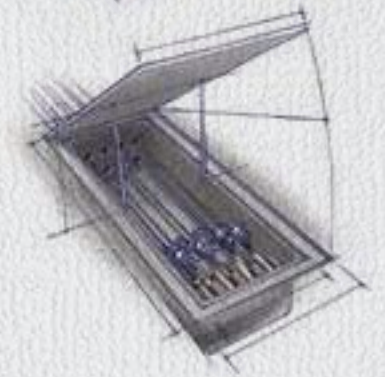

CONSOLES

Smoker Craft deluxe consoles put everything you need just a glance away. Their ergonomic designs position gauges so they're clearly visible while running, and toggle switches are always within easy, unobstructed reach. Hydraulic steering comes standard or is an option on many models.



Separating ourselves from the pack

Since 1963, Smoker Craft boats have stood for continuous innovation, standing out from the pack with numerous key features that make a big difference out on the water. Designed by anglers for anglers, here's just a sample of what you'll find on our 2020 lineup.

MEET THE NEW BOSS

THE NEW **VPS** HULL

From pro-style fishing to father-and-son outings, Smoker Craft boats feature the most impressive amenities. Better yet, they all come standard. Substantial rod storage, portable aerated Engel Live Bait Coolers, Integrated Gunnel Track System, accessible rigging, cockpit floor drains, automotive-style consoles and spacious floorplans deliver a great boating experience for all types of anglers. For 2020, Smoker Craft continues to push boundaries and drive innovation by introducing its exclusive new hull design, the Vertex Performance Strake™

The new VPS Hull provides best in class performance:

- Undisturbed water to prop
- Faster hole shot
- Quicker time to plane
- Higher & drier ride
- Greater stability
- Less HP required



FEATURED ON SELECT
ADVENTURER
SERIES BOATS

INTEGRATED GUNNEL TRACK SYSTEM

Smoker Craft's exclusive Integrated Gunnel Track System (IGTS) allows for easier installation of rod holders, downriggers and other accessories—without drilling a single hole anywhere in the boat. IGTS is the ideal foundation for factory-installed accessory packages from Bert's Custom Tackle, developed by legendary fishermen to meet the individual needs of serious anglers. Ask your dealer for details.



.YARBLOW. VENTILATION SYSTEM

Standard on all **Pro Mag** and **Explorer** series boats. Optional on **Ultima** and **Pro Angler XL** series boats.

Let's face it, on a fishing boat, gear sometimes gets put away wet. That's why Smoker Craft is proud to offer the exclusive Yarblow Ventilation System that circulates fresh air through rod lockers and storage spaces to protect expensive tackle from rust and corrosion. Pressurized air keeps mold and mildew from becoming established in storage compartments, as well as traditionally wet areas like the bilge, protecting your gear and the boat itself. It's all part of our commitment to providing peace of mind and giving you more value for your investment.

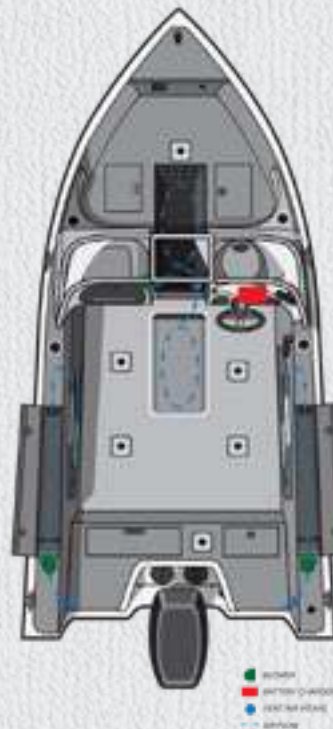

CONSTRUCTION YOU CAN COUNT ON.

UPHOLSTERY

Produced in-house for quality control and customization, Smoker Craft upholstery is precision cut and installed using only stainless, non-corrosive fasteners. Cushioning foam is biocide treated to help prevent mildew and fungal growth that can discolor vinyl. This process is a key differentiator when comparing Smoker Craft to other manufacturers.

CARPET & VINYL

Smoker Craft casting platforms and decks are covered in marine-grade carpet that is both glued and stapled, while cockpits feature easy-to-clean vinyl. Optional snap-in carpet can be added over the vinyl for added comfort.

EVA SOFT TOUCH TRACTION MATS

These mats are easy to clean; resistant to mold, mildew and stains; and offer superior wet or dry traction.

FLOOR PANELS

Our pressure-treated plywood floors are 5/8" in the cockpit and 3/4" on the casting decks. They carry a lifetime warranty and will not warp or rot.

INJECTED FOAM FLOTATION

Unlike other manufacturers, we inject foam flotation into pre-routed holes in the floor panels to fill the entire cavity under the floor. The adhesive property of our foam allows it to bond to both the floor panels and the hull, providing enhanced support and excellent sound dampening.

TWICE-BAKED PAINT FINISH

The Smoker Craft paint method includes 3 coats of base urethane and 3 coats of accent color, with baking under infrared heating coils after each step—giving it a twice-baked, diamond-hard finish that is resistant to chipping and fading, and looks great for years to come.

ZINC CHROMATE PRIMER

Zinc chromate primer is chemically etched into the aluminum hull, forming a corrosion-resistant surface. This also creates an even, bondable surface for the final paint layer.

HIGH-GRADE ALUMINUM

Smoker Craft boats start with 5052 H34 Cold-Rolled Aluminum for its superior strength, hardness and corrosion resistance. Computerized fabrication equipment delivers precision components and ensures consistent quality.

DOUBLE RIVETS

The sides and transom are riveted with a double row of airplane-style rivets on the seams on all models 17' and above. The rows are offset to completely seal the seam.



GENERATION 1 HYDRA-LIFT PERFORMANCE HULL

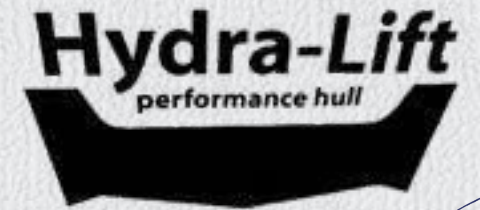

Our exclusive, proven-performance Generation 1 hull provides superior lift to get you out of the hole and on plane quickly. The reverse chine design keeps the bow down during acceleration, provides sportscar-style turning agility and offers exceptional stability both while running at high speeds and while at rest.

Generation 1 Hydra-Lift Performance Hulls are available on Explorer, Pro Mag, Ultima, and Pro Angler XL Series boats.

TRANSOM

The transom board is made of 1.5" pressure-treated plywood, which is covered by our Limited Lifetime Warranty. The board is sandwiched between the aluminum transom with a plastic layer to prevent corrosion and a second aluminum sheet is anchored using stainless steel bolts.



PERFORMANCE HULL SYSTEM

Our exclusive Performance Hull System (PHS) is a completely customizable trim tab feature that increases speed, reduces pounding, eliminates porpoising and provides improved efficiency with less fuel consumption and engine laboring. The system allows you to tune your hull to maximize performance, depending on the weight and horsepower of your engine. Additional benefits include improved visibility, reduced wake size, better handling and less hull stress. *Not available on Adventurer series.*



SPRAY RAILS

Spray rails are rolled into the side panels, giving a much cleaner appearance and eliminating the line-breaking rough edges found on many other boats. The combination of spray rails with the Hydra-Lift reverse chine design delivers the driest ride in the industry.

YARBLOW VENTILATION SYSTEM

The exclusive Yarblow Ventilation System protects your tackle and gear from rust and corrosion by using pressurized air to eliminate mold and mildew in the bilge and dry storage areas. See page 5 for more details.



SIDE PANELS

The side panels are strengthened by rolling lap strakes into the aluminum, adding rigidity to the sides that prevents the "oil can" appearance of many other boats.



INTEGRATED GUNNEL TRACK SYSTEM

The exclusive new Integrated Gunnel Track System (IGTS) is an innovative gunnel design that allows for easier installation of rod holders, downriggers and other accessories. See page 5 to learn more about this exciting new feature.



LED LIGHTING

Pro Mag and Explorer models feature the added style, safety and convenience of interior LED lighting.

Because the hottest bite can be early in the day or well after dark, select Smoker Craft boats feature state-of-the-art LED interior lighting for added safety and convenience. Unlike traditional courtesy lights, LEDs draw very little power, and you'll never need to replace a bulb again.



GAS TANK INTEGRATION

We place the gas tanks below the floor toward the center of the boat, between the floor stringers, to centralize the weight of the fuel. This gives the boat a softer ride and helps keep the bow down.

ONE-PIECE BOTTOM

The Hydra-Lift Hull begins with a one-piece bottom, unlike many other manufacturers. Aluminum gauge ranges from .100" to .125".



The Hydra-Lift Hull is supported by Smoker Craft's exclusive Advanced Integrated Rib System (AIRS). This integrates heavy machine-formed, hat-shaped ribs in the bow with cross ribs on 10" centers on the bottom. The bow ribs conform to the contour of the bow and angle toward the cross ribs to add strength to the critical area of the hull when the boat is running. Floor stringers are fastened to the cross ribs to support the floor panels and enhance hull strength.

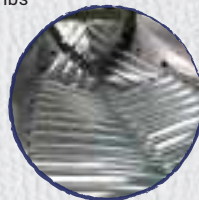

5-KEEL CONSTRUCTION

While many manufacturers have stopped adding keels, we continue to use up to 5 keels on our hulls to provide longitudinal strength and to protect the bottom when beaching or trailering. In addition, the keels help the boat plane quickly by breaking the water during acceleration. They also improve tracking and help maintain better boat control while fishing.



INNER STRENGTH

The legendary performance of Smoker Craft's Pro Mag and Explorer models comes from the tremendous strength of their proven hull design. A precision-welded framework built on longitudinal stringers is directly secured to the hull plate to create a solid, uniform structure.

LEGENDARY HANDLING

Our exclusive Hydra-Lift Hulls incorporate our Advanced Integrated Rib System (AIRS) that reinforces the hull's critical running surface when underway. Apart from providing smoother planing performance, Hydra-Lift improves handling in all water conditions for a more pleasing ride and better fuel economy.

HIGH AND DRY

Hydra-Lift Hulls raised eyebrows when they were first introduced, and they continue to lead the industry today with their smooth handling and dry ride. The combination of spray rails rolled into the side panels and Hydra-Lift's reverse-chine design beat down spray and keep water out of the boat—something you especially appreciate when heading out on those cold mornings early or late in the season.

GENERATION 2 VERTEX PERFORMANCE STRAKE™ HULL

Smoker Craft's all-new Generation 2 Vertex Performance Strake™ (VPS) hull sets the standard for high performance in aluminum fishing boat design, providing unrivaled acceleration, unequalled handling and the highest ride quality in the industry.



FEATURED ON SELECT

ADVENTURER

SERIES BOATS*

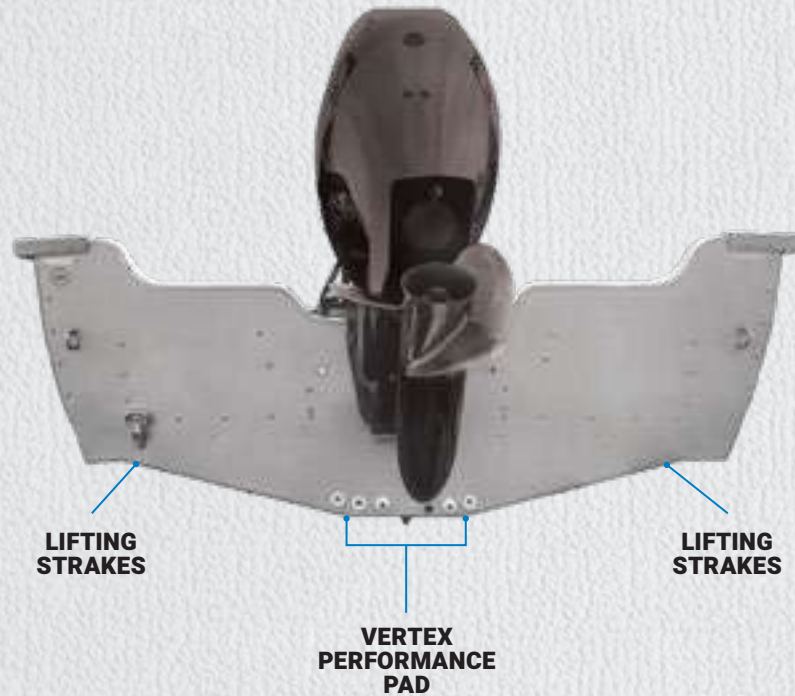

STERN LIVEWELL
Aerated, Timed, Recirculating
and Pumped Out

**ACCESS TO
LIVEWELL FITTINGS**

PUMP ACCESS

WIRE CHASE

WIRE CHASE

FULL FLOTATION FOAM



**STARBOARD
9' ROD STORAGE**





ENGEL LIVE BAIT WELL
with 12V Plug

BOW LIVE WELL
Aerated and Timed

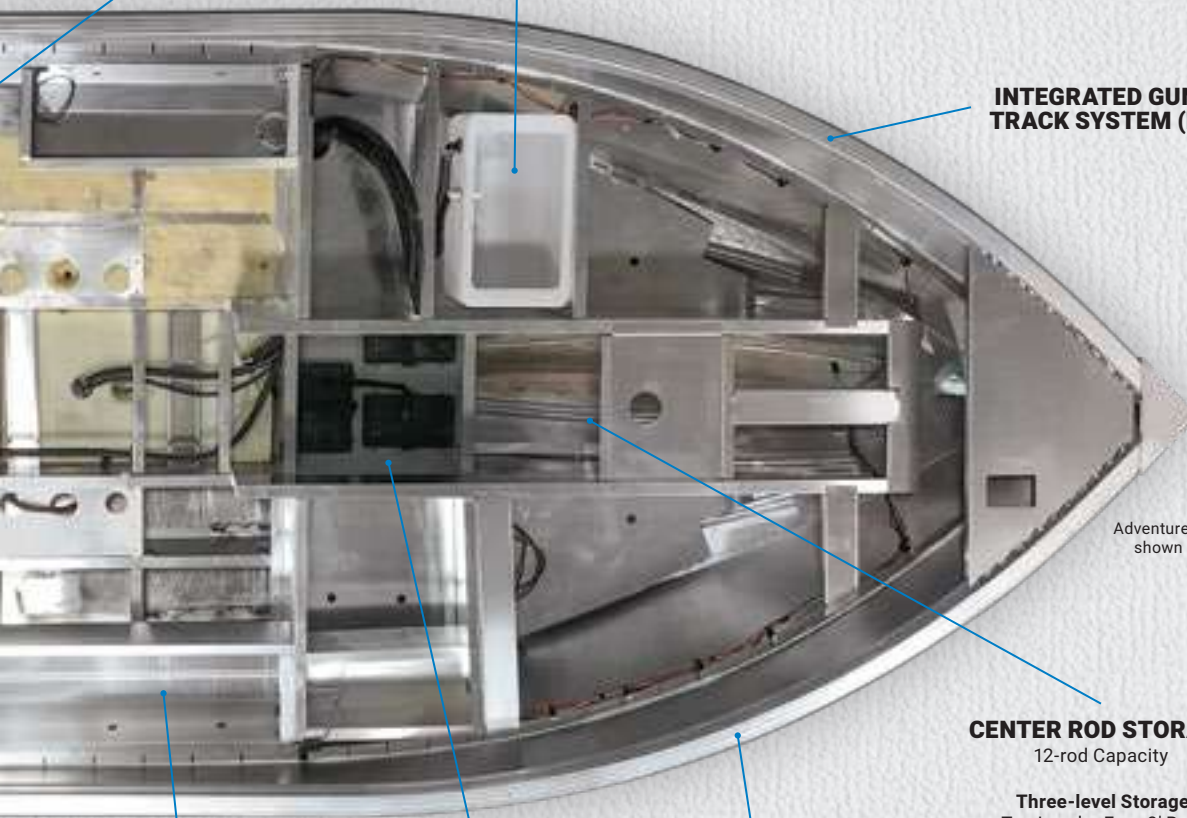

INTEGRATED GUNNEL TRACK SYSTEM (IGTS)

Adventurer 188 T
shown here

CENTER ROD STORAGE
12-rod Capacity

Three-level Storage:
Top Level – Four 8' Rods
Middle Level – Four 7' Rods
Lower Level – Four 6.5' Rods

FULL LENGTH COCKPIT DRAINAGE

BATTERY STORAGE
Inside Center Rod Storage

INTEGRATED GUNNEL TRACK SYSTEM (IGTS)

Specially designed, integrated performance strakes carve the surface as you open the throttle, feeding nothing but clean, undisturbed water to the propeller for maximum bite. That means noticeably faster hole shots and a quicker time to plane, even when running with a full tournament load. What's more, VPS keeps the boat on plane at lower speeds, so you can breeze through no-wake zones without making a splash.

Break out to the big water and you'll immediately feel the VPS difference, with its unprecedented stability and its higher, drier ride. That's something everyone can appreciate, especially in a good walleye chop.

Best of all, VPS lets you achieve this incredible level of performance with smaller, lighter, more fuel-efficient engines to help reduce ownership costs. Because let's face it, it's more fun to spend that extra cash on new tackle instead of gas.

ADVENTURER *fish without compromise*

FEATURING THE NEW **VPI** VERTEX PERFORMANCE STRAKE™ HULL

178 DC
Shown with optional equipment.



188 DC
Shown with optional equipment.



178 FS
Shown with optional equipment.

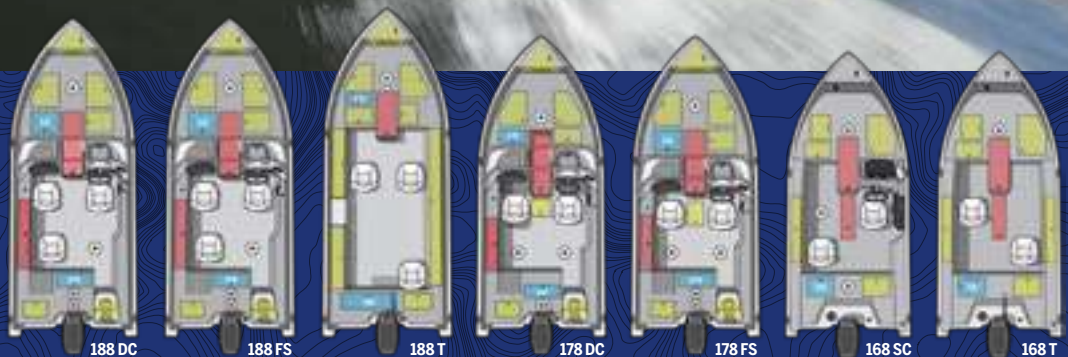

	Maximum HP	Fuel Capacity* (gal.)	Length	Beam	Dry Weight (lb)	Capacity (Persons/lb)	Seats	Interior Depth	Depth	Transom Height (Engine)	Bottom Gauge	Side Gauge	Deadrise at Transom
188 DC	175	38	18'11"	96"	1890	6 / 850	3	23"	41"	25"	.125"	.080"	15°
188 FS	175	38	18'11"	96"	1890	6 / 850	3	23"	41"	25"	.125"	.080"	15°
188 T	90	38	18'11"	96"	1890	5 / 700	3	23"	41"	25"	.125"	.080"	15°
178 DC	150	32	17'11"	96"	1731	6 / 825	3	22"	39"	25"	.125"	.080"	15°
178 FS	150	32	17'11"	96"	1731	6 / 825	3	22"	39"	25"	.125"	.080"	15°
168 SC	90	22	16'4"	92"	1135	5 / 700	2	24"	36"	20"	.100"	.070"	10°
168 T	60	22	16'4"	92"	1135	5 / 700	2	24"	36"	20"	.100"	.070"	10°

STANDARD FEATURES

- Heavy Gauge Aluminum Bottom
- Deluxe Wood-free Fishing Seats
- JENSEN AM / FM Stereo (N/A on 168 SC or 168 T)
- Lockable Center Rod Storage
- Integrated GUNNEL Track System (IGTS)
- IGTS Mood Lighting (N/A on 168 SC or 168 T)
- Durable Vinyl Cockpits
- Aerated, Timed, Recirculating and Pump Out Stern Livewell
- Lockable Bow Storage
- Vertex Performance Strake™ (VPS) Hull (N/A on 168 SC or 168 T)
- Removable Baitwell Cooler (Available Only on 188 T)
- Hydraulic Steering (Available on 188 DC, 188 FS, 188 T)
- Xtreme™ Tilt Steering (N/A on 188 DC, 188 FS, 188 T)
- Bow Cushions (Available Only on FS)
- Lifetime +6 Warranty



POPULAR OPTIONS

- Sonar Unit
- 12/24 Trolling Motor
- Battery Charger
- Snap-in Carpet
- Additional Fishing Seat
- Removable Baitwell Cooler (N/A on 168 SC or 168 T)
- Snap-on Mooring Cover
- Trailerable Ratchet Cover
- Fisherman's Top (N/A on 168 SC or 168 T)
- Full Enclosure (N/A on 168 SC or 168 T)
- Depth Gauge
- Trim Gauge
- Ski Tow Pylon (N/A on 168 SC or 168 T)
- Swim Platform with 3-Step Ladder

COLOR OPTIONS



Silver Metallic + White + Red Accent



Silver Metallic + Blue



Silver Metallic + Black + Red Accent (188 T only)



Silver Metallic + Black (168 SC, 168 T only)

Hydraulic steering is required for all 150HP and above.

* Smoker Craft uses diurnal EPA certified tanks which may hold less than listed content by approximately 10%.

To see more information on our fine Smoker Craft fishing boats, visit SMOKERCRAFT.COM.

PRO MAG

182 172

MAXIMUM HP
150-175

LENGTH
17'3"-18'2"

BEAM
96"

Whether it's a fun afternoon with the kids or pride on the line at a weekend tournament, Smoker Craft's Pro Mag takes the prize with its Yarbrow Ventilation System, Integrated Gunnel Track System for easy installation of rod holders, downriggers and other accessories, flush-mount electronics, contemporary LED lighting, massive in-deck rod storage and exclusive FreshCatch Pro recirculating aerated livewells with timer control.





Featuring the **YARBLOW**
VENTILATION SYSTEM

PRO MAG *built for the pros*



172
Shown with optional Bert's Custom
Tackle Angler Cradle Package, trolling
motor and flush-mounted sonar unit.



OPTIONAL SPLIT FLIP-UP BENCH SEAT (182)





182

Shown with optional Bert's Custom Tackle Pro Package, flip-up bench, 3-step boarding ladder, two downriggers, trolling motor and flush-mounted sonar unit.



STANDARD FEATURES

- Lockable Bow Center Rod Storage with T-locks (Stores up to Nine Rods [182] or Six Rods [172])
- Hydraulic Steering (182)
- Deluxe Console with Chrome-accented Gauges (Speedometer, Tachometer, Voltmeter and Fuel)
- Pro Capacity Recirculating Livewells
 - Bow: FreshCatch: 15-gallon
 - Stern: FreshCatch Pro: 25-gallon
- Yarblow Ventilation System
- Integrated Gunnel Track System (IGTS)
- Full Vinyl Cockpits and Casting Platforms
- EVA Soft Touch Traction Mat (Top Decks Only)
- Interior LED Lighting
- Wood-free Deluxe Fishing Seats (up to Six Seat Bases)
- Onboard, 2-bank Battery Charger
- Cockpit Sea Weave Flooring
- Lifetime +6 Warranty



POPULAR OPTIONS

- All-weather Package (see page 46 for details)
- Power Package (see page 46 for details)
- Trolling Motor with Quick Disconnect
- In-Dash Lowrance® Sonar Unit
- Ram Mount Humminbird® Sonar Unit
- Full Enclosure – Side, Aft, Walk-Thru and Bow Cover (only available for dual console models)
- Fisherman's Top
- Snap-On Mooring Cover
- SeaStar™ Hydraulic Steering (172)
- Flip-Up Bench Seat (172)
- 3-step Boarding Ladder
- Additional Fishing Seat
- Snap-in Carpet
- Depth Gauge
- Trailerable Ratchet Cover



	Maximum HP	Fuel Capacity* (gal.)	Length	Beam	Dry Weight (lb)	Capacity (Persons/lb)	Seats	Interior Depth	Depth	Transom Width	Transom Height (Engine)	Bottom Gauge	Side Gauge	Rib Gauge	Deadrise at Transom
182	175	25	18'2"	96"	1425	8 / 1100	3	27"	41"	96"	25"	.125"	.080"	.125"	17°
172	150	22	17'3"	96"	1415	7 / 1000	3	25"	40"	88"	25"	.100"	.080"	.125"	17°

COLOR OPTIONS



Silver Metallic + Blue

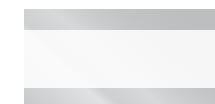

Silver Metallic + White

Hydraulic steering is required for all 150HP and above.

* Smoker Craft uses diurnal EPA certified tanks which may hold less than listed content by approximately 10%.

EXPLORER

182 172

MAXIMUM HP
150-175

LENGTH
17'3"-18'2"

BEAM
96"

Saturday tournaments with your best buddy. Sunday joy rides with the family. Smoker Craft's versatile Explorer series knows no limits, especially when it comes to family fun. Flip-up stern jump seats, inviting bow cushions and an optional ski tow offer something for everyone, while the large bow and stern raised casting decks, large casting platforms and state-of-the-art consoles are for the serious fishermen. Lockable rod storage keeps your gear safe, while the exclusive Integrated Gunnel Track System lets you easily customize your boat with rod holders, downriggers and more.





Featuring the **YARBLOW**
VENTILATION SYSTEM

EXPLORER *live life without limits*

182
Shown with optional Bert's Custom Tackle
Package, trolling motor and sonar unit.



OPTIONAL IN-DASH SONAR UNIT (182)





OPTIONAL BERT'S CUSTOM TACKLE ACCESSORIES



172
Shown with optional Bert's Custom Tackle Angler Tube Package, two 6" riser cradles, ski pylon, trolling motor and sonar unit.



STANDARD FEATURES

- Convertible Walk-through Bow Casting Platform
- Hydraulic Steering (182)
- Deluxe Console with Chrome-accented Gauges (Speedometer, Tachometer, Voltmeter and Fuel)
- Pro Capacity Recirculating Livewells
 - (182) Bow: FreshCatch: 12-gallon
 - (182) Stern: FreshCatch Pro: 25-gallon
 - (172) Bow: FreshCatch: 12-gallon
 - (172) Stern: FreshCatch Pro: 15-gallon
- Yarblow Ventilation System
- Integrated Gunnel Track System (IGTS)
- Full Vinyl Cockpits and Casting Platforms
- EVA Soft Touch Traction Mat (Top Decks Only)
- Interior LED Lighting
- Rear Flip-up Jump Seats
- Wood-free Deluxe Fishing Seats (up to Six Seat Bases)
- Bow Cushions
- Onboard, 2-bank Battery Charger
- Cockpit Sea Weave Flooring
- Lifetime +6 Warranty



POPULAR OPTIONS

- All-weather Package (see page 46 for details)
- Power Package (see page 46 for details)
- Trolling Motor with Quick Disconnect
- In-dash Lowrance® Sonar Unit
- Ram Mount Humminbird® Sonar Unit
- Full Enclosure (Side, Aft, Walk-Thru & Bow Cover)
- Fisherman's Top
- Snap-on Mooring Cover
- SeaStar™ Hydraulic Steering (172)
- 3-step Boarding Ladder
- Additional Fishing Seat
- Snap-in Carpet
- Depth Gauge
- Trailerable Ratchet Cover

COLOR OPTIONS



Silver Metallic + Blue



Silver Metallic + White



	Maximum HP	Fuel Capacity* (gal.)	Length	Beam	Dry Weight (lb)	Capacity (Persons/lb)	Seats	Interior Depth	Depth	Transom Width	Transom Height (Engine)	Bottom Gauge	Side Gauge	Rib Gauge	Deadrise at Transom
182	175	25	18'2"	96"	1425	8 / 1100	3	27"	41"	96"	25"	.125"	.080"	.125"	17°
172	150	22	17'3"	96"	1305	7 / 1000	3	25"	40"	88"	25"	.100"	.080"	.125"	17°

Hydraulic steering is required for all 150HP and above.

* Smoker Craft uses diurnal EPA certified tanks which may hold less than listed content by approximately 10%.

Ultima

182 172

MAXIMUM HP
150-175

LENGTH
17'3"-18'2"

BEAM
96"

Is it the ultimate fishing boat for families or the ultimate family boat for anglers? Either way, Ultima is the budget-friendly family favorite with its convertible bow casting platform, flip-up jump seats in the stern and a handsomely upholstered cockpit interior that speaks to its tremendous versatility. Of course, there's lockable in-floor storage for both rods and skis, plus large bow and stern aerated livewells and even an available ski pylon.





Ultima *the ultimate in versatility*

182
Shown with optional Bert's
Custom Tackle Package, trolling
motor and sonar unit.



OPTIONAL 3-STEP BOARDING LADDER





172
Shown with optional trolling motor, sonar unit and ski pylon.



STANDARD FEATURES

- Convertible Walk-through Bow Casting Platform
- Lockable In-floor Rod Storage
- Convertible Ski Storage
- Port and Starboard Lockable, Top-loading Rod Storage
- Deluxe Console with Chrome-accented Gauges (Speedometer, Tachometer, Voltmeter and Fuel) and AM/FM Stereo with Speakers
- Xtreme™ Steering
- Tilt Steering
- Aerated, Recirculating Livewells
 - (182) Bow: FreshCatch: 12-gallon
 - (182) Stern: FreshCatch Pro: 25-gallon
 - (172) Bow: FreshCatch: 12-gallon
 - (172) Stern: FreshCatch Pro: 15-gallon
- Integrated Gunnel Track System (IGTS)
- Vinyl Cockpits and Casting Decks
- EVA Soft Touch Traction Mat (Top Decks Only)
- Rear Flip-up Jump Seats
- Wood-free Deluxe Fishing Seats (up to Six Seat Bases)
- Durable .100-gauge (172) and .125-gauge (182) One-piece Hull
- Lifetime +6 Warranty



POPULAR OPTIONS

- All-weather Package (see page 46 for details)
- Power Package (see page 46 for details)
- Family Ski Package (includes ski pylon and 2-step boarding ladder)
- Trolling Motor with Quick Disconnect
- Sonar Unit
- LED Interior Lighting
- Battery Charger
- Yarblow Ventilation System
- Full Enclosure
- Fisherman's Top
- Mooring Cover
- Bow Cover
- Ski Pylon
- 48" Track Lock
- Additional Deluxe Fishing Seat
- 3-step Boarding Ladder
- Snap-in Carpet
- Depth Gauge
- Hydraulic Steering (standard on 182)
- Trailerable Ratchet Cover



	Maximum HP	Fuel Capacity* (gal.)	Length	Beam	Dry Weight (lb)	Capacity (Persons/lb)	Seats	Interior Depth	Depth	Transom Width	Transom Height (Engine)	Bottom Gauge	Side Gauge	Rib Gauge	Deadrise at Transom
182	175	25	18'2"	96"	1425	8 / 1100	3	27"	41"	96"	25"	.125"	.080"	.125"	17°
172	150	22	17'3"	96"	1305	7 / 1000	3	25"	40"	88"	25"	.100"	.080"	.125"	17°

Hydraulic steering is required for all 150HP and above.

* Smoker Craft uses diurnal EPA certified tanks which may hold less than listed content by approximately 10%.

To see more information on our fine Smoker Craft fishing boats, visit SMOKERCRAFT.COM.

COLOR OPTIONS



Silver Metallic + Blue



Silver Metallic + White

Ultima

the ultimate in versatility

LEGACY



182
Shown with optional trolling motor and sonar unit.



DELUXE CONSOLE WITH OPTIONAL SONAR UNIT





OPTIONAL TROLLING MOTOR WITH QUICK DISCONNECT



182
Shown with optional trolling motor and sonar unit.



STANDARD FEATURES

- Convertible Walk-through Bow Casting Platform
- Lockable In-floor Rod Storage
- Convertible Ski Storage
- Port and Starboard Lockable, Top-loading Rod Storage
- LED Interior Lighting
- Deluxe Console with Chrome-accented Gauges (Speedometer, Tachometer, Voltmeter and Fuel) and AM/FM Stereo with Speakers
- Xtreme™ Steering (172)
- Hydraulic Steering (182)
- Aerated, Recirculating Livewells
 - (182) Bow: FreshCatch: 12-gallon
 - (182) Stern: FreshCatch Pro: 25-gallon
 - (172) Bow: FreshCatch: 12-gallon
 - (172) Stern: FreshCatch Pro: 15-gallon
- Vinyl Cockpits and Casting Decks
- Rear Flip-up Jump Seats
- Wood-free Deluxe Fishing Seats (up to Six Seat Bases)
- Bow Cushions
- Durable .100-gauge (172) and .125-gauge (182) One-piece Hull
- Lifetime +6 Warranty



POPULAR OPTIONS

- All-weather Package (see page 46 for details)
- Power Package (see page 46 for details)
- Family Ski Package (includes ski pylon and 2-step boarding ladder)
- Trolling Motor with Quick Disconnect
- Sonar Unit
- Battery Charger
- Full Enclosure
- Fisherman's Top
- Mooring Cover
- Bow Cover
- Ski Pylon
- Additional Deluxe Fishing Seat
- 3-step Boarding Ladder
- Snap-in Carpet
- Hydraulic Steering (standard on 182)
- Tilt Steering
- Trailerable Ratchet Cover



	Maximum HP	Fuel Capacity* (gal.)	Length	Beam	Dry Weight (lb)	Capacity (Persons/lb)	Seats	Interior Depth	Depth	Transom Width	Transom Height (Engine)	Bottom Gauge	Side Gauge	Rib Gauge	Deadrise at Transom
182 LEGACY	175	25	18'2"	96"	1425	8 / 1100	3	27"	41"	96"	25"	.125"	.080"	.125"	17°
172 LEGACY	150	22	17'3"	96"	1305	7 / 1000	3	25"	40"	88"	25"	.100"	.080"	.125"	17°

COLOR OPTIONS



White + Black with Gray Stripe

White + Black with Red Stripe

Hydraulic steering is required for all 150HP and above.

* Smoker Craft uses diurnal EPA certified tanks which may hold less than listed content by approximately 10%.

To see more information on our fine Smoker Craft fishing boats, visit SMOKERCRAFT.COM.



PRO ANGLER XL

182 XL 172 XL 171 XL 162 XL 161 XL

MAXIMUM HP
90-175

LENGTH
16'4"-18'2"

BEAM
92"-96"

Pro Angler XL leads its class with feature-packed value in a deep, beamy hull that provides more interior space. The large, elevated bow casting deck conceals deep storage lockers for bulky gear and still has space for a FreshCatch livewell, while the spacious main cockpit offers plenty of freeboard and the Integrated Gunnel Track System for mounting downriggers, rod holders and other accessories wherever they're needed. Lockable rod storage keeps expensive tackle safely out of sight when not in use, and its durable vinyl cockpit floor makes cleanup a snap.



PRO ANGLER XL

because size does matter



182 XL
Shown with optional Bert's Custom Tackle Package, trolling motor and sonar unit.

172 XL
Shown with optional Bert's Custom Tackle Package, trolling motor and sonar unit.

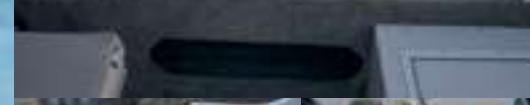



STANDARD FEATURES

- Automotive-style Console with Speedometer, Tachometer and Fuel Gauge and Lighted Rocker Switches
- Port and Starboard Lockable, Top-loading Rod Storage
- AM/FM Stereo (182 XL, 172 XL, 171 XL)
- Xtreme™ Steering
- Hydraulic Steering (182 XL)
- Extra-large Pro Capacity Recirculating Livewells
 - (182 XL) Bow: FreshCatch: 15-gallon
 - (182 XL) Stern: FreshCatch Pro: 25-gallon
 - (172 XL) Bow: FreshCatch: 15-gallon
 - (172 XL) Stern: FreshCatch Pro: 25-gallon
 - (162 XL) Bow: FreshCatch: 15-gallon
- Integrated Gunnel Track System (IGTS)
- Vinyl Cockpits
- EVA Soft Touch Traction Mat (Top Decks Only)
- Large Bow and Stern Casting Platforms
- Comfortable, Ergonomic Wood-free Fishing Seats (up to Six Seat Bases on 172 XL; up to Five Seat Bases on 162 XL, 161 XL)
- Durable .100-gauge (172 XL, 171 XL, 162 XL, 161 XL) and .125-gauge (182 XL) One-piece Hull
- Lifetime +6 Warranty



POPULAR OPTIONS

- All-weather Package (see page 46 for details)
- Power Package (see page 46 for details)
- Trolling Motor with Quick Disconnect
- Sonar Unit
- LED Interior Lighting
- Battery Charger
- Split Flip-up Bench Seat (N/A 161 XL)
- Additional Fishing Seat
- Yarblow Ventilation System
- Full Enclosure
- Mooring Cover
- Fisherman's Top
- Bow or Cockpit Cover
- 3-step Boarding Ladder
- Snap-in Carpet
- Depth Gauge
- AM/FM Stereo (162 XL, 161 XL)
- Hydraulic Steering (standard on 182 XL)
- Trailerable Ratchet Cover

161 XL
Shown with optional Bert's Custom Tackle Package, trolling motor and sonar unit.

162 XL
Shown with optional trolling motor and sonar unit.



	Maximum HP	Fuel Capacity* (gal.)	Length	Beam	Dry Weight (lb)	Capacity (Persons/lb)	Seats	Interior Depth	Depth	Transom Width	Transom Height (Engine)	Bottom Gauge	Side Gauge	Rib Gauge	Deadrise at Transom
182 XL	175	25	18'2"	96"	1425	8 / 1100	3	27"	41"	96"	XLS	.125"	.080"	.125"	17°
172 XL	150	22	17'3"	96"	1305	7 / 1000	3	25"	40"	88"	XLS	.100"	.080"	.125"	17°
171 XL	150	22	17'3"	96"	1305	7 / 1000	3	25"	40"	88"	XLS	.100"	.080"	.125"	17°
162 XL	90	20	16'4"	92"	1140	5 / 700	2	27"	37"	84"	LS	.100"	.070"	.125"	10°
161 XL	90	22	16'4"	92"	1140	5 / 700	2	27"	37"	88"	LS	.100"	.070"	.125"	10°

Hydraulic steering is required for all 150HP and above.

* Smoker Craft uses diurnal EPA certified tanks which may hold less than listed content by approximately 10%.

To see more information on our fine Smoker Craft fishing boats, visit SMOKERCRAFT.COM.

COLOR OPTIONS



Silver Metallic + Blue



Silver Metallic + White





PRO ANGLER

172 162 161

MAXIMUM HP
60 – 140

LENGTH
16'2" – 16'10"

BEAM
81" – 92"

You cast for bass in the morning, troll for muskie at mid-day then jig for walleyes before heading in. Multi-species anglers need a versatile boat, and Pro Angler delivers. We're talking oversized, raised bow and stern casting platforms, a massive 25-gallon FreshCatch aerated livewell, lockable rod storage and an automotive-style console with full gauges and plenty of space for electronics. With its wood-free fishing seats and a heavy gauge .100" one-piece bottom, this is one fishing buddy that's in it for the long haul.



PRO ANGLER *the multi-species champion*

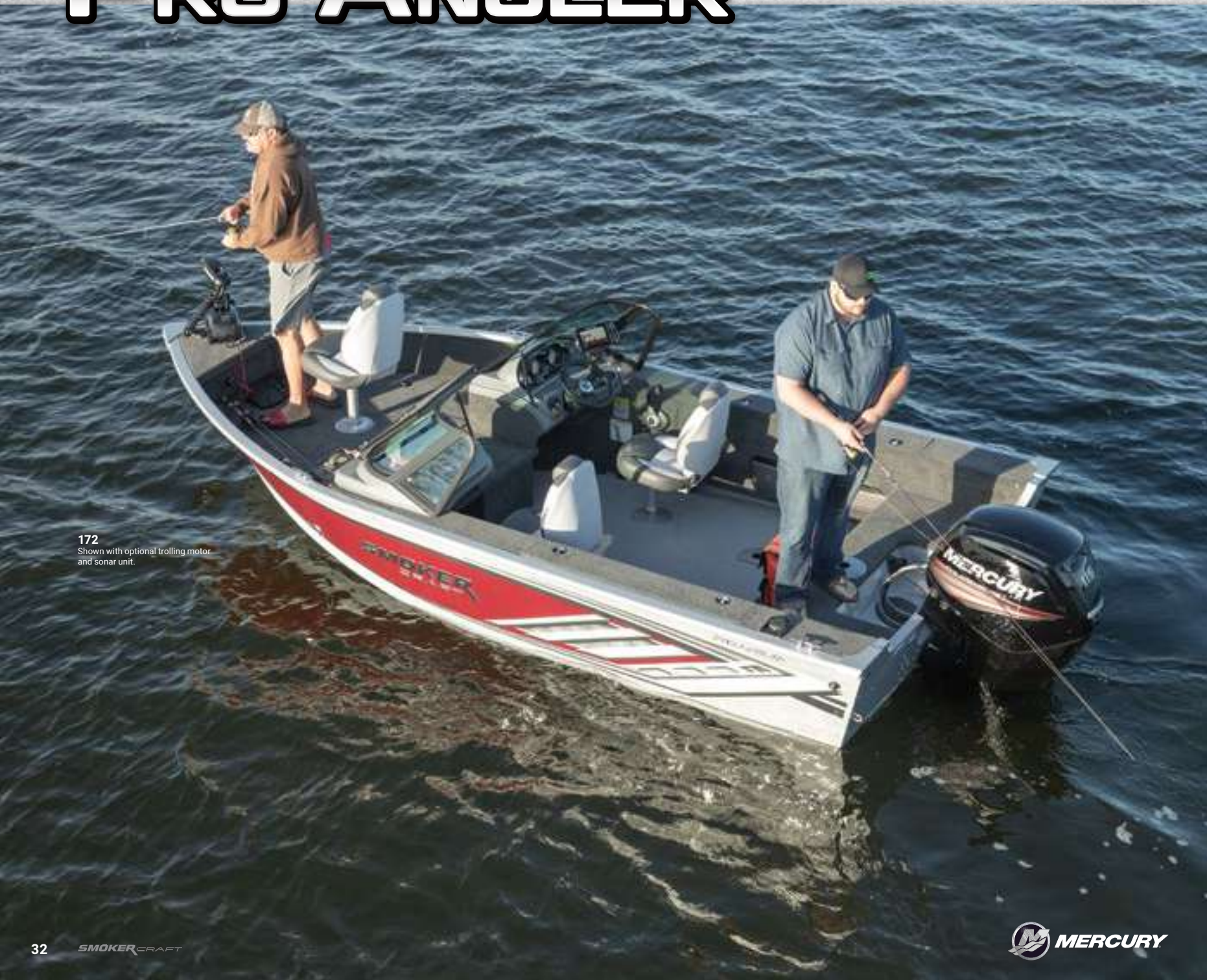

172
Shown with optional trolling motor
and sonar unit.



OPTIONAL REAR FLIP-UP BENCH SEAT (172)





161
Shown with optional trolling motor and sonar unit.



STANDARD FEATURES

- Automotive-style Console with Speedometer, Tachometer and Fuel Gauge and Lighted Rocker Switches
- Port and Starboard Lockable, Top-loading Rod Storage
- FreshCatch 25-gallon Livewell
- Wood-free Fishing Seats (up to Six Seat Bases on 172; up to Five Seat Bases on 162, 161)
- Vinyl Cockpits
- Large Bow and Stern Casting Platforms with 18-oz. Carpet
- Durable .100-gauge One-piece Hull
- Lifetime +6 Warranty



POPULAR OPTIONS

- All-weather Package (see page 46 for details)
- Power Package (see page 46 for details)
- Trolling Motor with Quick Disconnect
- Sonar Unit
- Battery Charger
- Split Flip-up Bench Seat (N/A 161)
- Additional Fishing Seat
- Full Enclosure
- Mooring Cover
- Fisherman's Top
- Bow or Cockpit Cover
- 3-step Boarding Ladder
- Snap-in Carpet
- Depth Gauge
- AM/FM Stereo
- Hydraulic Steering
- Xtreme™ Steering
- No Feedback Tilt Steering

COLOR OPTIONS

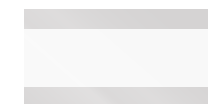

Silver Metallic + White



Silver Metallic + Burgundy



	Maximum HP	Fuel Capacity* (gal.)	Length	Beam	Dry Weight (lb)	Capacity (Persons/lb)	Seats	Interior Depth	Depth	Transom Width	Transom Height (Engine)	Bottom Gauge	Side Gauge	Rib Gauge	Deadrise at Transom
172	140	22	16'10"	92"	1225	5 / 675	3	24"	34"	91"	LS	.100"	.080"	.100"	14°
162	60	15	16'2"	81"	845	5 / 680	2	25"	33"	74"	LS	.100"	.070"	.100"	10°
161	60	15	16'2"	81"	845	5 / 680	2	25"	33"	74"	LS	.100"	.070"	.100"	10°

ANGLER

STANDARD FEATURES

- 7-ply Pressure Treated Floor and Deck
- Two Wood-free Fishing Seats
- Durable Vinyl Cockpits and Casting Platforms
- Lockable Rod Storage
- Lifetime +6 Warranty



POPULAR OPTIONS

- Humminbird® HELIX 5 GPS with Raw Mount
- Trolling Motor
- Snap-on Mooring Cover
- Additional Fishing Seat
- Power Pedestal
- Seat Slider

COLOR OPTION



White

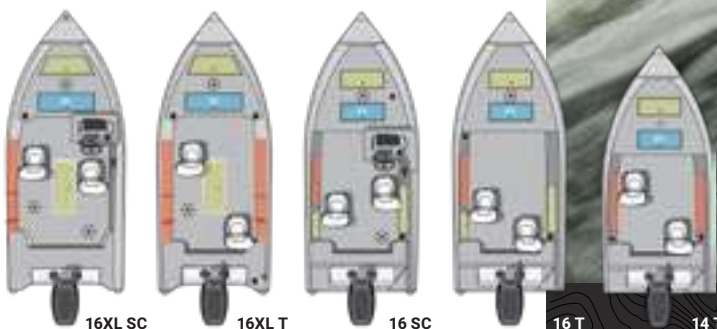

16 SC
Shown with optional trolling motor.



FRESHCATCH 25-GALLON LIVEWELL



REAR SPLASH PAN



16 T

	Maximum HP	Fuel Capacity* (gal.)	Length	Beam	Dry Weight (lb)	Capacity (Persons/lb)	Seats	Interior Depth	Depth	Transom Ht. (Engine)	Bottom Gauge	Side Gauge	Deadrise at Transom
16XL SC	60	PORTABLE TANK	16'2"	81"	685	5/680	2	25"	33"	20"	.100"	.080"	10°
16XL T	60	PORTABLE TANK	16'2"	81"	625	5/680	2	25"	33"	20"	.100"	.080"	10°
16 SC	60	PORTABLE TANK	16'4"	78"	685	5/670	2	20.5"	23"	20"	.080"	.060"	15°
16 T	40	PORTABLE TANK	16'4"	78"	625	5/670	2	20.5"	23"	20"	.080"	.060"	15°
14 T	40	PORTABLE TANK	14'8"	77"	540	4/555	2	20.5"	23"	20"	.080"	.060"	15°

* Smoker Craft uses diurnal EPA certified tanks which may hold less than listed content by approximately 10%.

FREEDOM



160 SC
Shown with optional trolling motor.



OPEN FLOOR SPACE FOR FISHABILITY



DELUXE CONSOLE (160 SC)



FRESHCATCH 25-GALLON LIVEWELL



180 SC
Shown with optional trolling motor and sonar unit.

STANDARD FEATURES

- 7-ply Pressure Treated Floor and Deck
- Two Wood-free Fishing Seats
- Durable Vinyl Cockpits and Casting Platforms
- Port Livewell
- Lifetime +6 Warranty



POPULAR OPTIONS

- Trolling Motor
- Snap-on Mooring Cover
- Additional Fishing Seat
- Power Pedestal
- Seat Slider

COLOR OPTIONS



Black



Beige

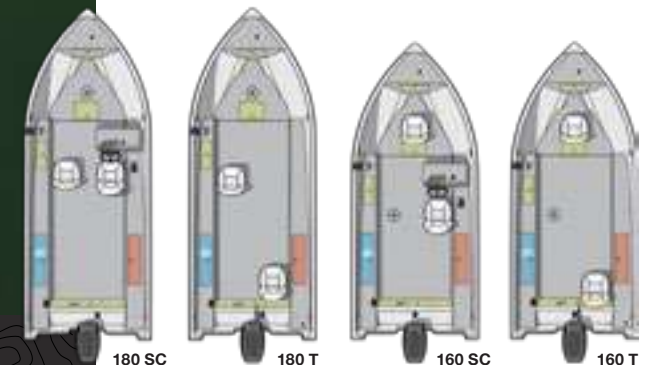

	Maximum HP	Fuel Capacity* (gal.)	Length	Beam	Dry Weight (lb)	Capacity (Persons/lb)	Seats	Interior Depth	Depth	Transom Width	Transom Ht. (Engine)	Bottom Gauge	Side Gauge	Deadrise at Transom
180 SC	125	21	18'11"	89"	1005	6/1840	2	22"	35"	85"	LS	.100"	.080"	10°
180 T	90	21	18'11"	89"	1005	6/1840	2	22"	35"	85"	LS	.100"	.080"	10°
160 SC	90	21	16'11"	89"	875	6/900	2	22"	35"	85"	LS	.100"	.080"	10°
160 T	75	21	16'11"	89"	875	6/900	2	22"	35"	85"	LS	.100"	.080"	10°

NORTH AMERICAN ANGLER

WHEN IT'S TIME TO BRING YOUR "A" GAME.

No matter where you love to fish, the American Angler Series by Smoker Craft is up to the challenge. Big water? Rough weather? These all-welded hulls are ready for anything with their exclusive Torsion Beam Construction built for exceptional strength and shock absorption—plus the peace of mind of a lifetime warranty.





THE INDUSTRY'S BEST WARRANTY. PERIOD.

Only a company with the proven history and longevity of a brand like American Angler by Smoker Craft can offer something like this:

- Limited lifetime warranty on hull and structure
- 6-year warranty on all components, carpet, upholstery and electronics
- All parts and labor
- Transferable to second owner



TWICE-BAKED PAINTED HULLS

American Angler full painted hulls provide showroom looks designed to last for years.

MACHINE FORMED RIBS*

Our unique machine formed ribs are stronger and more flexible than the two-ply aluminum used by many competitors.

TORSION BEAM CONSTRUCTION*

Instead of the flat I-Beams that you find in many boats, American Angler uses our exclusive Torsion Beam Construction (TBC) stringer system for exceptional strength and shock absorption.

ALL-WELDED CONSTRUCTION

Every American Angler series boat offers the toughness and reliability of all-welded marine-grade aluminum construction that's backed by a lifetime warranty.

INJECTED FOAM FLOTATION

American Angler models feature injected foam, not poured, between the floor and hull—filling all air pockets. This provides greater strength and buoyancy and reduces noise.

* Pro Lodge, Pro Tracer and Osprey series

Phantom *where big water meets its match*



20 X2

Shown with optional equipment and Bert's Custom Tackle Package.



DRIVER'S CONSOLE



WALK THROUGH WINDSHIELD



OPTIONAL SIDE JUMP SEATS



OPEN ROD STORAGE AND INTEGRATED GUNNEL TRACK SYSTEM WITH OPTIONAL BERT'S CUSTOM TACKLE ACCESSORIES



DUAL CONSOLE AND IN-FLOOR ROD STORAGE

STANDARD FEATURES

- Treated Floor with Lifetime Warranty
- Full Vinyl Floor
- Elevated Console
- Tachometer, Speed, Volt and Fuel Gauges
- Under-console Storage
- Open Rod Storage
- Tackle Tray
- Toe Holds
- Hydraulic Steering
- Integrated Gunnel Track System (IGTS)
- Coaming Gunnel with Watershed Channel
- Bow Fish Box
- Wash Down Kit
- Navigation Lights
- Dual Auto Bilge Pumps



POPULAR OPTIONS

- Bow Mount Anchor Release
- Bow Rails
- Stern Rails
- Wiper
- Fisherman's Top with Side, Walk Through and Drop Curtains
- Rigid Frame Soft Top
- Jump Seats with Storage Box
- Fish Package
- Fuel Water Separator
- Trolling Motor Plug
- Additional Seat

COLOR OPTIONS



White

Black



18 X2

Shown with optional equipment and Bert's Custom Tackle.



Shown with optional jump seats.



	Maximum HP	Fuel Capacity* (gal.)	Length	Beam	Dry Weight (lb)	Capacity (Persons/lb)	Seats	Interior Depth	Depth	Transom Width	Transom Height (Engine)	Bottom Gauge	Side Gauge	Deadrise at Transom
20 X2	175	47	20'5"	98"	1778	6 / 850	2	33"	47"	96"	25"	.160"	.125"	19°
18 X2	150	38	18'6"	98"	1680	6 / 800	2	33"	45"	96"	25"	.160"	.125"	15°

Hydraulic steering is required for all 150HP and above.

* Smoker Craft uses diurnal EPA certified tanks which may hold less than listed content by approximately 10%.

Osprey *the sporty side of serious fishing*

172
Shown with optional side jump seats.



HONDA
MARINE



OSPREY 172



STORAGE BOX



OPTIONAL SIDE JUMP SEAT AND
OPEN ROD STORAGE



FULL VINYL COCKPIT AND CASTING DECK



BOW LIVEWELL

STANDARD FEATURES

- Treated Floor with Lifetime Warranty
- Full Vinyl Floor
- Elevated Console
- Tachometer, Speed, Volt and Fuel Gauges
- Under Console Storage
- Open Rod Storage
- Tackle Tray
- Toe Holds
- Tilt Steering
- In-floor Fish Box
- Fisherman's Top with Side, Walk Through and Drop Curtains
- Bow Fish Box/Livewell
- Navigation Lights
- Bilge Pump



POPULAR OPTIONS

- Side Jump Seats
- Bow Mount Anchor Release
- Bow Rails
- Additional Fishing Seat
- Hydraulic Steering
- Trolling Motor Plug

COLOR OPTION



White



HONDA
MARINE

162
Shown with optional side jump seats.

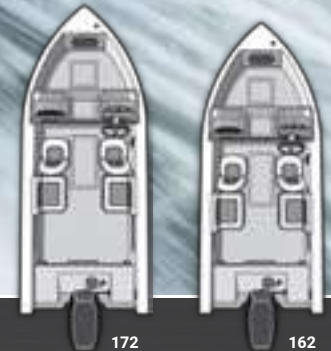

172

162

	Maximum HP	Fuel Capacity* (gal.)	Length	Beam	Dry Weight (lb)	Capacity (Persons/lb)	Seats	Interior Depth	Depth	Transom Width	Transom Height (Engine)	Bottom Gauge	Side Gauge	Deadrise at Transom
172	150	25	17'4"	90"	1165	6 / 850	2	27"	41"	90"	20"	.100"	.100"	17°
162	115	23	16'4"	90"	1075	6 / 765	2	27"	39"	90"	20"	.100"	.100"	17°

Hydraulic steering is required for all 150HP and above.

* Smoker Craft uses diurnal EPA certified tanks which may hold less than listed content by approximately 10%.

162

Shown with optional side jump seats.



Pro Tracer

lighten up for easier towing

STANDARD FEATURES

- Treated Floor with Lifetime Warranty
- Full Vinyl Floor
- Elevated Console
- Fuel Gauge
- Under Console Storage
- Bow Storage
- Open Rod Storage
- Tackle Tray
- Toe Holds
- Bow Livewell
- Bow Rail
- Navigation Lights
- Bilge Pump
- Fisherman's Top with Side, Walk Through and Drop Curtains



POPULAR OPTIONS

- Trolling Motor Plug
- Four Cleats
- Downrigger Brackets
- Bow Mount Anchor Release
- Side Jump Seats
- Additional Fishing Seat

COLOR OPTION

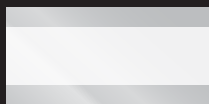

White



HONDA
MARINE

162 PRO TRACER
Shown with optional side jump seats.



PASSENGER CONSOLE



DRIVER'S CONSOLE

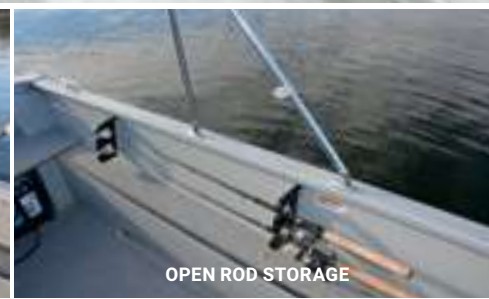

OPEN ROD STORAGE



OPTIONAL SIDE-BY-SIDE JUMP SEATS

	Maximum HP	Fuel Capacity* (gal.)	Length	Beam	Dry Weight (lb)	Capacity (Persons/lb)	Seats	Interior Depth	Depth	Transom Width	Transom Height (Engine)	Bottom Gauge	Side Gauge	Deadrise at Transom
162	90	12	16'6"	82"	1025	6 / 815	2	24"	37"	79"	20"	.100"	.100"	10°



open for adventure **Pro Lodge**



162 PRO LODGE
Shown with optional trolling motor and sonar.

STANDARD FEATURES

- Treated Floor with Lifetime Warranty
- Full Vinyl Floor
- Open Rod Storage
- Tackle Tray
- Toe Holds
- Bow Storage
- Bow Livewell
- Dual Storage Boxes with Swivel Seats
- Pedestal Driver's Seat
- Navigation Lights
- Bilge Pump



POPULAR OPTIONS

- Side Console
- Two Downrigger Brackets
- Bow Mount Anchor Release
- Bow Rails
- Additional Fishing Seat
- Trolling Motor Plug

COLOR OPTION

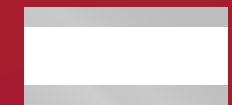

White



OPTIONAL SIDE CONSOLE



EXTRA-WIDE INTERIOR



SEAT BOX WITH STORAGE



	Maximum HP	Fuel Capacity* (gal.)	Length	Beam	Dry Weight (lb)	Capacity (Persons/lb)	Seats	Interior Depth	Depth	Transom Width	Transom Height (Engine)	Bottom Gauge	Side Gauge	Deadrise at Transom
160	60	12	16'3"	82"	995	6 / 815	2	24"	37"	79"	20"	.100"	.100"	10°

* Smoker Craft uses diurnal EPA certified tanks which may hold less than listed content by approximately 10%.

Pro Sportsman

STANDARD FEATURES

- Treated Floor with Lifetime Warranty
- Full Vinyl Floor
- Fuel Gauge
- Bow Storage
- Open Rod Storage
- Tackle Tray
- Toe Holds
- Livewell
- Upgraded Graphics



POPULAR OPTIONS

- Trolling Motor Plug
- Four Cleats
- Downrigger Brackets
- Bow Mount Anchor Release
- Additional Fishing Seats
- Seat Box with Storage
- Bow Livewell

COLOR OPTIONS

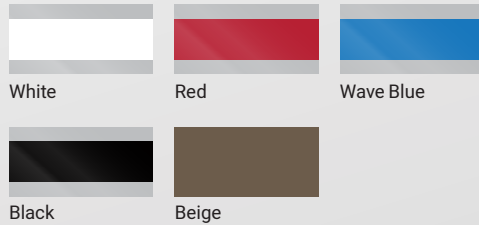

2072 T



2072 CC
Shown with optional center console.



CENTER CONSOLE BENCH



CENTER CONSOLE



1872 T

	Maximum HP	Fuel Capacity* (gal.)	Length	Beam	Dry Weight (lb)	Capacity (Persons/lb)	Seats	Interior Depth	Depth	Transom Width	Transom Height (Engine)	Bottom Gauge	Side Gauge	Deadrise at Transom
2072 CC	175	33	20'6"	99"	1778	6 / 850	2	27"	33.5"	92"	25"	.160"	.125"	10°
2072 DC	175	33	20'6"	99"	1778	6 / 850	2	27"	33.5"	92"	25"	.160"	.125"	10°
2072 T	150	33	20'6"	99"	1678	6 / 850	2	27"	33.5"	92"	25"	.160"	.125"	10°
1872 CC	150	33	18'6"	99"	1518	6 / 850	2	27"	33.5"	92"	25"	.160"	.125"	14°
1872 DC	150	33	18'6"	99"	1518	6 / 850	2	27"	33.5"	92"	25"	.160"	.125"	14°
1872 T	100	33	18'6"	99"	1418	6 / 850	2	27"	33.5"	92"	25"	.160"	.125"	14°

Sportsman



1866 PRO
Shown with optional side console, fishing seat and stern rails.



STANDARD FEATURES

- Treated Floor with Lifetime Warranty
- Full Vinyl Floor
- Fuel Gauge
- Bow Storage
- Open Rod Storage
- Tackle Tray
- Toe Holds



POPULAR OPTIONS

- High-Back Seat with Swivel
- Seat Box with Storage
- Center Console
- Side Console
- Windscreen
- Trolling Motor Plug
- Four Cleats
- Bow Rails
- Stern Rails
- Downrigger Brackets
- Bow Mount Anchor Release
- Additional Fishing Seats

COLOR OPTIONS

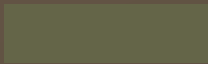
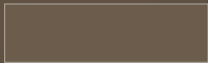
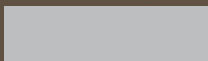
-  OD Green
-  Beige
-  Silver Metallic



SEAT BOX WITH STORAGE



SIDE CONSOLE (1866, 1660)



OPTIONAL CENTER CONSOLE

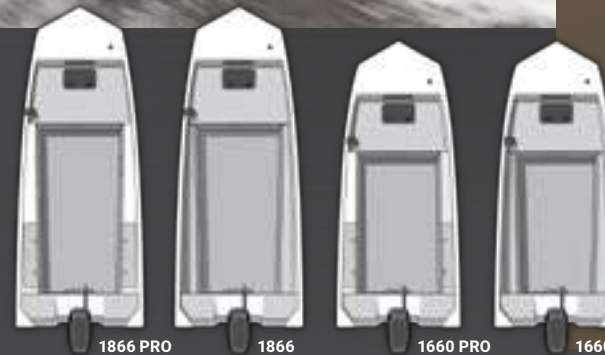

1866 PRO

1866

1660 PRO

1660



	Maximum HP	Fuel Capacity* (gal.)	Length	Beam	Dry Weight (lb)	Capacity (Persons/lb)	Seats	Interior Depth	Depth	Transom Width	Transom Height (Engine)	Bottom Gauge	Side Gauge	Deadrise at Transom
1866 PRO	90	32	18'7"	94"	875	6 / 825	2	26"	29"	92"	20"	.100"	.100"	10°
1866	90	32	18'7"	94"	875	6 / 825	2	26"	29"	92"	20"	.100"	.100"	10°
1660 PRO	70	17	16'11"	86"	700	6 / 825	2	23"	26"	88"	20"	.100"	.100"	10°
1660	70	17	16'7"	86"	700	6 / 825	2	23"	26"	88"	20"	.100"	.100"	10°

* Smoker Craft uses diurnal EPA certified tanks which may hold less than listed content by approximately 10%.

Resorter

STANDARD FEATURES

- Automotive-style Console with Speedometer, Tachometer and Lighted Rocker Switches
- FreshCatch 18-gallon Center Bow Livewell
- Two Wood-free Fishing Seats (up to Six Seat Bases)
- Large Dry Bow Storage and Side-mounted Rod Holders
- Large Bow and Stern Casting Platforms with 18 Oz. Carpet
- Vinyl Cockpit for Easy Cleanup and Durability
- Heavy Gauge .100" Aluminum One-piece Bottom
- Lifetime +6 Warranty



POPULAR OPTIONS

- Power Package (see page 48 for details)
- Trolling Motor with Quick Disconnect
- Battery Charger
- Additional Fishing Seat
- 2-step Boarding Ladder
- Mooring Cover
- Depth Finder

COLOR OPTION



Black



151 RESORTER
Shown with optional trolling motor and sonar unit.



LIVEWELL



BOW CASTING PLATFORM WITH CARPET



DRIVER'S CONSOLE
Shown with optional sonar unit

	Maximum HP	Fuel Capacity* (gal.)	Length	Beam	Dry Weight (lb)	Capacity (Persons/lb)	Seats	Interior Depth	Depth	Transom Width	Transom Ht. (Engine)	Bottom Gauge	Side Gauge	Rib Gauge	Deadrise at Transom
151	50	PORTABLE TANK	15'2"	75"	675	4/580	2	23"	30"	73"	LS	.100"	.064"	.064"	5°



Utilities



15' ALASKAN TS/TL
SPLIT SEAT DLX



13' ALASKAN TS/TL
SPLIT SEAT DLX



1648 JON

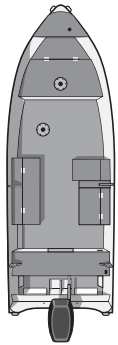

16' BIG FISHERMAN

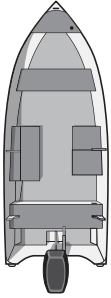

14' BIG FISHERMAN



16' VOYAGER



14' VOYAGER



14' CANADIAN



12' CANADIAN

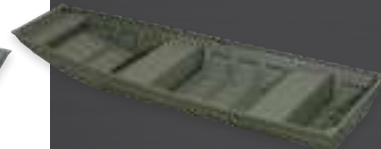

1448 JON



1436 JON

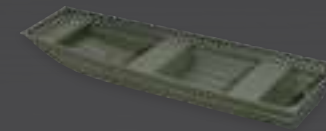

1232 JON

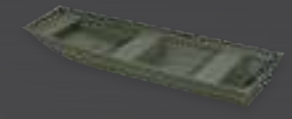

1032 JON



15' ALASKAN TS/TL SPLIT SEAT DLX



OPTIONAL CONSOLE



OPTIONAL BUILT-IN LIVEWELL

	Maximum HP	Fuel Capacity (gal.)	Overall Length	Beam	Depth	Interior Depth	Transom Width	Transom Height (Engine)	Dry Weight (lb)	Maximum Persons	Maximum Capacity (lb)	Color	Bottom Gauge	Side Gauge	Rib Gauge
16' BIG FISHERMAN	30	N/A	16'5"	70"	31"	22"	63"	LS	460	5	965	Black	.070"	.060"	.064"
14' BIG FISHERMAN	30	N/A	14'2"	68"	30"	22"	60"	LS / SS	395	4	825	Black	.070"	.060"	.064"
15' ALASKAN TL SPLIT SEAT DLX	35	N/A	14'11"	68"	27"	21"	59"	LS	270	4	850	Gray	.070"	.060"	.064"
15' ALASKAN TS SPLIT SEAT DLX	35	N/A	14'11"	68"	27"	21"	59"	SS	270	4	850	Gray	.070"	.060"	.064"
13' ALASKAN TL SPLIT SEAT DLX	20	N/A	12'11"	66"	26"	20"	56"	LS	225	3	625	Gray	.064"	.060"	.064"
13' ALASKAN TS SPLIT SEAT DLX	20	N/A	12'11"	66"	26"	20"	56"	SS	225	3	625	Gray	.064"	.060"	.064"
16' VOYAGER	30	N/A	16'2"	68"	29"	20"	56"	LS	290	5	965	Black	.100"	.060"	.064"
14' VOYAGER	30	N/A	14'2"	68"	30"	30"	60"	LS / SS	230	4	825	Black	.070"	.060"	.064"
14' VOYAGER SPLIT SEAT	35	N/A	14'2"	68"	30"	30"	60"	LS / SS	230	4	1000	Black	.070"	.060"	.064"
14' CANADIAN	15	N/A	13'10"	59"	20"	20"	50"	SS	130	4	700	White	.050"	.050"	.050"
12' CANADIAN	10	N/A	11'9"	56"	20"	20"	50"	SS	112	3	600	White	.050"	.050"	.050"
1648 JON	35	N/A	16'0"	72"	22"	22"	71"	LS / SS	295	4	900	Olive	.080"	.080"	.072"
1448 JON	25	N/A	14'0"	72"	22"	22"	71"	LS / SS	260	3	900	Olive	.080"	.080"	.072"
1436 JON	20	N/A	14'0"	57"	18"	18"	56"	SS	185	3	395	Olive	.080"	.080"	.064"
1232 JON	6	N/A	12'0"	51"	16"	16"	50"	SS	120	2	390	Olive	.050"	.050"	.050"
1032 JON	3	N/A	10'0"	51"	16"	16"	50"	SS	100	2	290	Olive	.050"	.050"	.050"

COLOR OPTIONS



BLACK



WHITE



OLIVE



GRAY

FEATURES AND OPTIONS

Talk with your dealer about these available performance upgrade packages.



POWER PACKAGE

Includes Trolling Motor with Quick Disconnect, Sonar Unit and Power Prep – Factory-Rigged Motor and Accessories.



ALL-WEATHER PACKAGE

Includes Mooring Cover, Snap-in Carpet and Fisherman's Top.



PREMIUM STEERING PACKAGE

Ask your dealer how you may optimize your boat's performance with premium steering options.



BERT'S CUSTOM TACKLE PACKAGES

Crafted to accommodate your personal angling gear, these tackle packages keep equipment in its place.

Personalize and optimize your Smoker Craft and North American Angler

Smoker Craft Interior



DRIVER'S CONSOLE



OPTIONAL FLUSH-MOUNT SONAR



OPTIONAL DEPTH GAUGE



OPTIONAL SNAP-IN CARPET



OPTIONAL BOW CUSHIONS



OPTIONAL FLIP-UP JUMP SEAT



DELUXE FISHING SEAT



OPTIONAL ON BOARD BATTERY CHARGER

Smoker Craft Sound



STEREO



OPTIONAL KICKER STEREO

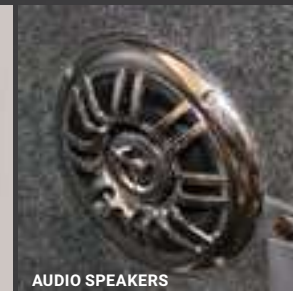

AUDIO SPEAKERS

Smoker Craft Tops and Enclosures



OPTIONAL FULL ENCLOSURE



OPTIONAL FISHERMAN'S TOP



OPTIONAL MOORING COVER

with a wide range of features and options.

North American Angler Interior



Smoker Craft Exterior



North American Angler Exterior



Smoker Craft Livewell Options

From evening dinner to that coveted trophy fish, Smoker Craft's FreshCatch aerated livewells keep every catch safe and fresh.

FRESHCATCH

Our aerated livewells are timed for convenience and feature a PowerStream nozzle, a single bilge and black thru-hulls.



FRESHCATCH PRO

Our pro livewells are aerated, timed and feature a recirculating pump to move more water and oxygen into the tanks to keep fish active. Highlights include black thru-hulls and PowerStream aerator and nozzle.



	20 X2 PHANTOM	18 X2 PHANTOM	172 OSPREY	162 OSPREY	162 PRO TRACER	160 PRO LODGE	2072 PRO SPORTSMAN CC	2072 PRO SPORTSMAN DC	2072 PRO SPORTSMAN T	1872 PRO SPORTSMAN CC	1872 PRO SPORTSMAN DC	1872 PRO SPORTSMAN T	1866 PRO SPORTSMAN	1866 SPORTSMAN	1660 PRO SPORTSMAN	1660 SPORTSMAN
COLORS																
Blue	S	S
Black	S	S	S	S	S	S	S	S
White	S	S	S	S	S	S	S	S	S	S	S	S
Red	S	S	S	S	S	S
Wave Blue	S	S	S	S	S	S
Beige	S	S	S	S	S	S	S	S	S	S
OD Green	S	S	S	S	S	S	S
Silver Metallic	S	S	S	S	S	S	S
HULL																
V-Hull	S	S	S	S	S	S	S	S	S
Mod V-Hull	S	S	S	S	S	S	S
FLOOR/CARPET																
Treated Floor with Lifetime Warranty	S	S	S	S	S	S	S	S	S	S	S	S	S	S	S	S
Vinyl Floor Covering	S	S	S	S	S	S	S	S	S	S	S	S	S	S	S	S
CONSOLE/DASH																
Safety Glass Windshield	S
Curved Safety Glass Windshield	.	.	S	S
Welded Safety Glass Windshield	S	S
Elevated Console	S	S	S	S	S
Tachometer	S	S	S	S
Speedometer	S	S	S	S
Volt Meter	S	S	S	S	.	.	S	S	S
Fuel Gauge	S	S	S	S	S	S
LIVWELL																
Stern Livewell (gal.)
Bow Livewell (gal.)	.	.	(26)	(26)	(26)	(26)
SEATING																
Seat Storage Boxes	2	0	0	0	0	0	0	0	0	0	0
Seat Storage Boxes with Hatch	2	3
Deluxe Helm & Companion	0	0
High-back Cushioned/Foldable	2	2
Pedestals	2	2	2	2	.	1	0	0	0	0	0	0	0	0	0	0
Jump Seats	0	0	0	0	0	0
STORAGE																
Under-console Storage with Shelf	S	S	S	S	S
Bow Storage	S	S	S	S	S	S	S	S	S	S	S	S	S	S	S	S
Open Rod Storage	S	S	S	S	S	S	S	S	S	S	S	S	S	S	S	S
MISCELLANEOUS																
Tackle Tray	S	S	S	S	S	S	S	S	S	S	S	S	S	S	S	S
Toe Holds	S	S	S	S	S	S	S	S	S	S	S	S	S	S	S	S
Navigation Lights	S	S	S	S	S	S	S	S	S	S	S	S	S	S	S	S
Steering	S	S	S	S	S	Tiller	Tiller	Tiller	Tiller	Tiller	Tiller	Tiller	Tiller	Tiller	Tiller	Tiller
Tilt Steering	.	.	S	S
Hydraulic Tilt Steering	S	S	0	0
Bilge Pump	S	S	S	S	S	S	S	S	S	S	S	S	S	S	S	S
NMMA Certification	S	S	S	S	S	S	S	S	S	S	S	S	S	S	S	S
Injected Foam Flotation	S	S	S	S	S	S	S	S	S	S	S	S	S	S	S	S
Bow Rails	0	0	0	0	S	0
Coaming Gunnel with Watershed Channel	S	S	.	.	.	S	S	S
Cleats	S	S	.	.	.	S	S	S
In-floor Fish Box	0	0	S	S
Offshore Bracket with Auxiliary Mount	S	S
Bow Fish Box	S	S	S	S	S	S	S	S
Transom Fish Box with Sink Basin	S	S
Transom Doors	0	0	0	0	0	0	.	.	.	0	0	0	0	0	0	0
Wash-down Kit	0	0	0	0	0	0	0	0	0	0	0	0	0	0	0	0
Tower	0	0	0	0	0	0	.	.	.	0	0	0	0	0	0	0
CANVAS																
Fisherman's Top	0	0	S	S	S
Side Curtains	0	0	S	S	S
Walk-through Curtain	0	0	S	S	S
Drop Curtain	0	0	S	S	S

S | Standard 0 | Option . | Not Available A | Aerated R | Recirculating T | Timed



To see more information on our fine Smoker Craft boats, visit smokercraft.com.



SMOKER CRAFT

TO SEE MORE INFORMATION ON OUR FINE
SMOKER CRAFT BOATS, VISIT SMOKERCRAFT.COM

TO TALK TO THE DEALER NEAREST YOU, DIAL 866-719-7873.
Connects directly to dealer. Please call during business hours.